

## HygroClip DIGITAL

### Humidity and temperature probe



<b>HygroClip2 DIGITAL</b>	<b>rotronic</b>
E-M-HCD-V1_0.docx	Instruction manual

## Contents

<b>1</b>	<b>Overview</b> .....	<b>3</b>
1.1	Hardware and software compatibility .....	3
<b>2</b>	<b>Variants</b> .....	<b>4</b>
<b>3</b>	<b>General information</b> .....	<b>5</b>
3.1	Power supply.....	5
3.2	Measured parameters .....	5
3.3	Digital interface .....	5
3.4	Communication protocol .....	6
3.5	Connector .....	8
3.6	Sensor protection (filters) .....	9
<b>4</b>	<b>User settings</b> .....	<b>11</b>
4.1	Function overview .....	11
4.2	Factory defaults.....	12
<b>5</b>	<b>Mechanical installation</b> .....	<b>13</b>
<b>6</b>	<b>Electrical installation</b> .....	<b>14</b>
<b>7</b>	<b>Maintenance</b> .....	<b>15</b>
7.1	Filter cleaning.....	15
7.2	Regular calibration .....	15
<b>8</b>	<b>Firmware update</b> .....	<b>16</b>
<b>9</b>	<b>Technical specifications</b> .....	<b>17</b>
<b>10</b>	<b>Accessories</b> .....	<b>20</b>
<b>11</b>	<b>Additional documents</b> .....	<b>21</b>
<b>12</b>	<b>Document version</b> .....	<b>22</b>

<b>HygroClip2 DIGITAL</b>	<b>rotronic</b>
E-M-HCD-V1_0.docx	<b>Instruction manual</b>

## **Scope:**

This manual is applicable to the HCD probe series with firmware version V1.x. The low-order digit of the firmware version stands for minor changes, e.g. correction of errors, that do not influence the main functionality of the device.

# **1 Overview**

The HCD probe series is based on digital AirChip4000 technology. The probes have a UART interface. The HCD probe series is developed for use with all RMS data loggers.

The HCD can be operated independently using the digital protocols, for example for integration into OEM applications. The following functions are available via the digital interface:

- Change device settings
- Humidity and temperature adjustment
- Simulator mode

With the firmware update for the HCD, it is possible at any time to enable the latest HCD functions, even on older devices.

## **1.1 *Hardware and software compatibility***

The HCD is compatible only with RMS-generation devices. To change the HCD device configuration, the RMS-CONFIG software is required.

<b>HygroClip2 DIGITAL</b>	<b>rotronic</b>
E-M-HCD-V1_0.docx	<b>Instruction manual</b>

## 2 Variants

The HCD will come in various variants. Currently only the standard clip is available.

The HCD can be connected directly to a PC or network. Suitable accessories can be found in the **E-M-HC2-accessories** manual.

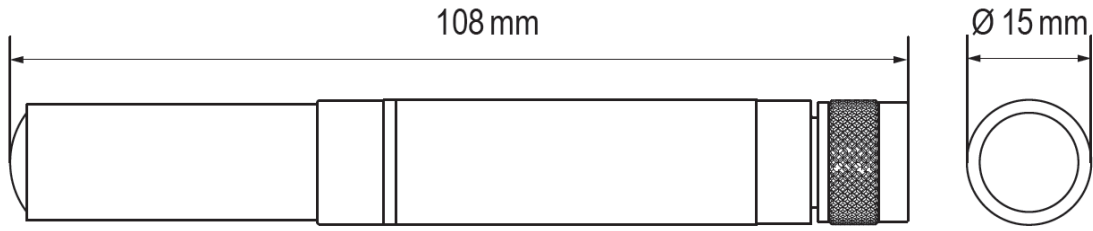
Climate measurements		
HCD-S	Accuracy:	$\pm 0.8\% \text{RH}$ , $\pm 0.1 \text{ K}$ at $10 \dots 30 \text{ }^\circ\text{C}$
	Humidity measurement range:	$0 \dots 100\% \text{RH}$
	Temperature measurement range:	$-40 \dots +85 \text{ }^\circ\text{C}$ ( $-40 \dots +185 \text{ }^\circ\text{F}$ )
	Diameter:	15 mm (0.6")
	Length:	108 mm (3.3")
	Housing material:	Polycarbonate, black
	Standard filter:	Polyethylene, $40 \text{ }\mu\text{m}$
	Sensor:	HYGROMER® HT-1
Weight:	10 g (0.35 oz)	
		

<b>HygroClip2 DIGITAL</b>	<b>rotronic</b>
E-M-HCD-V1_0.docx	<b>Instruction manual</b>

### **3 General information**

#### **3.1 *Power supply***

The HCD requires a power supply of 3.3...5 VDC.

#### **3.2 *Measured parameters***

The HCD measures relative humidity with the ROTRONIC HYGROMER® HT-1 and a Pt1000 temperature sensor.

#### **3.3 *Digital interface***

The HCD probe has a UART interface, via which the probe can be addressed directly using the MODBUS protocol. To connect the probe to a PC, an AC3001 service cable is required (**E-M-HC2-accessories**).

Using the ROTRONIC RMS-CONFIG software, the following functions are available via the UART interface.

- Read out measurements
- Probe information: name, serial number, calibration and adjustment information, etc.
- Probe calibration and adjustment
- Configuration
- Firmware update

<b>HygroClip2 DIGITAL</b>	<b>rotronic</b>
E-M-HCD-V1_0.docx	<b>Instruction manual</b>

### 3.4 *Communication protocol*

The probe can be addressed directly using the MODBUS protocol, to request the measured humidity and temperature values. The parameters highlighted in yellow should be selected according to the table below.

#### Command: (MSB first)

Probe address	Command ID		Start address		Number of records	MODBUS-CRC <sup>1</sup>
0x00	0x04	0x00	0x00	0x00	0x00	0x0000

Probe address: 0...255, if '0' then all probes respond regardless of the address.

Start address	Number of records	Return values			
0x00	0x04	Serial number	Humidity	Temperature	
		0x00000000	0x0000	0x0000	
0x00	0x02	Serial number			
		0x00000000			

#### Response:

Probe address	Command ID	Number of data bytes	Data (4...10 bytes)	MODBUS CRC
0x00	0x04	0x00	0x00, 0x00, 0x00, 0x00, 0x00, 0x00, 0x00, 0x00, 0x00, 0x00	0x0000

#### Data format:

- Serial number (unsigned int): 0...2<sup>32</sup>-1
- Humidity (unsigned int): 0...10000 corresponding to 0.00...100.00 %RH
- Temperature (signed int): -4000...+8500 corresponding to -40.00...+85.00 °C

<sup>1</sup> CRC calculation according to MODBUS standard

<b>HygroClip2 DIGITAL</b>	<b>rotronic</b>
E-M-HCD-V1_0.docx	<b>Instruction manual</b>

**Response in the event of an error:**

<b>Probe address</b>		<b>Error code</b>	<b>MODBUS CRC</b>
0x00	0x84	0x00	0x0000

<b>Error codes</b>	<b>Description</b>
0x02	Start address and number of records invalid
0x03	Number of records invalid

**Sensor faults:**

In the event of a short circuit or open circuit at the probe, a value of 19999 is output for the measured value concerned.

### 3.5 Connector

All HCD probes use the same connector (male).

Connection diagram (7-pin connector, male – view: probe side)

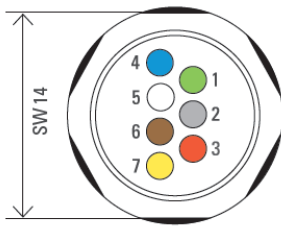





- 1) V+
- 2) GND
- 3) UART RxD
- 4) UART TxD
- 5) –
- 6) –
- 7) GND



### 3.6 Sensor protection (filters)

Most probes are supplied with a filter. The following filters and filter carriers are additionally available as accessories:

Filter carrier				
Order code	Image	Drawing	Material	Temperature range
SPA-PCB			Polycarbonate, black	-50...+100 °C (-58...+212 °F)
SPA-PCW			Polycarbonate, white	-50...+100 °C (-58...+212 °F)
SPA-SS			Stainless steel, 1.4301	-100...+200 °C (-148...+392 °F)

Filter					
	Only carrier	Wire mesh filter	PE filter	PTFE filter	Stainless steel
<b>Filter</b>					
<b>Material</b>	PC / 1.4301	1.4401	Polyethylene	PTFE	1.4404
<b>Pore size</b>	-	10 µm	40 µm	10 µm	25 µm
<b>Temperature range</b>	-	-100...+200 °C	-50...+100 °C	-80...+200 °C	-100...+200 °C
<b>Response time %RH<sup>2</sup></b>	12 s	12 s	15 s	18 s	15 s
<b>Response time °C<sup>3</sup></b>	80 s	180 s	180 s	170 s	-
<b>Response time °C<sup>4</sup></b>	120 s	190 s	210 s	210 s	200 s
<b>Waterproof (immersion 50 mm)</b>	No	No	Yes	Yes	No
<b>Max. wind speed</b>	5 m/s	50 m/s	50 m/s	50 m/s	70 m/s
<b>Suitable for particulates</b>	No	No	>10 µm	Yes	No
<b>General information</b>	Fast response time	High temperature, fast response time, fast drying, mechanically robust	Standard filter	High chemical resistance, particulates, high temperature	High wind speed, abrasive environment, high mechanical protection
<b>Applications</b>	Sterilization, H <sub>2</sub> O <sub>2</sub> , handheld devices	Meteorology, agriculture, climate chambers, storerooms, cheese cellars	HVAC, offices, storerooms, labs, clean rooms	Clean rooms, medicine, spray paint booths, flour production	HVAC with high wind speed, industrial applications

<sup>2</sup> T63: 100 %RH → 30 %RH

<sup>3</sup> PC carrier: 70 °C → 23 °C

<sup>4</sup> Stainless steel carrier 70 °C → 23 °C

<b>HygroClip2 DIGITAL</b>	<b>rotronic</b>
E-M-HCD-V1_0.docx	<b>Instruction manual</b>

## 4 User settings

The probe is supplied with the factory configuration as described in section 4.2 . Users can change this configuration as required. The probe also offers various functions which are described briefly here.

### 4.1 Function overview

Calibration	
AirChip4000 functions	Description
▶ Humidity/temperature adjustment	<ul style="list-style-type: none"> <li>○ 1-point or multi-point humidity adjustment/calibration</li> <li>○ 1-point or 2-point temperature adjustment/calibration</li> <li>○ Output the last calibration/adjustment, with date</li> <li>○ Produce a calibration/adjustment log</li> </ul>

Measurement loop validation	
AirChip4000 functions	Description
▶ Simulator mode	Is used to output fixed values for humidity, temperature. The output value can be configured.

Protect device settings	
AirChip4000 functions	Description
▶ Device write protection	Protects the device's settings with a password to prevent unauthorized access.

Fault detection	
AirChip4000 functions	Description
▶ Sensor alarm	The probe outputs a digital alarm if the sensor has a short circuit or open circuit. This function cannot be deactivated.

<b>HygroClip2 DIGITAL</b>	<b>rotronic</b>
E-M-HCD-V1_0.docx	<b>Instruction manual</b>

## 4.2 *Factory defaults*

<b>Configurable settings</b>	<b>Factory default</b>
Unit of measurement (metric/English)	Metric
Psychrometric calculation	None
Communication protocol	MODBUS
MODBUS address	0
Device name	HCD

<b>Functions</b>	<b>Factory default</b>
Humidity/temperature adjustment	Factory adjusted
Write-protection for device settings	Disabled
Simulator mode	Disabled

## 5 Mechanical installation

For best measurement results, observe the following points:

- Install the probe at a representative location for the process being monitored. Avoid the following:
  - Probe near a heating or cooling element, next to a wall, in direct sunlight, etc.
  - Probe near a steam inlet, humidifier, or atmospheric precipitation
  - Pressure fluctuations, e.g. in compressed air systems
- The probe should not be installed above a heating element.
- High airflow if possible, faster than 1 m/s.
- If installed through a wall, make sure the probe is inserted as far as possible into the environment being measured.

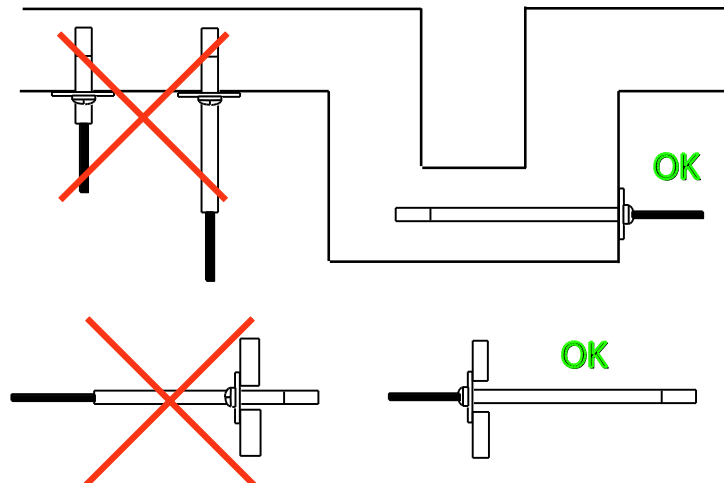

During installation, make sure that no condensation can collect on or in the probe and cause a short circuit at the sensor connections. Probes should be installed with the sensors at the bottom. This allows waste heat from the electronics to escape upward. If not possible, then horizontal installation is also acceptable.

For installation accessories, see the accessories manual: **E-M-HC2-accessories**.

<b>HygroClip2 DIGITAL</b>	<b>rotronic</b>
E-M-HCD-V1_0.docx	<b>Instruction manual</b>

## **6 Electrical installation**

Use Rotronic extension cables. These allow a maximum length of 3 m.

HygroClip2 DIGITAL	<b>rotronic</b>
E-M-HCD-V1_0.docx	Instruction manual

## 7 Maintenance

### 7.1 *Filter cleaning*

Depending on the application, the filter should be checked regularly for soiling, and replaced if necessary.

### 7.2 *Regular calibration*

HCD sensors have high long-term stability and do not require any additional calibration as supplied.

Long-term stability is better than 1 %RH per year. We recommend calibrating the probe every 6 to 12 months, depending on the application. Calibration or adjustment can be carried out using the RMS-CONFIG or RMS server software.

<b>HygroClip2 DIGITAL</b>	<b>rotronic</b>
E-M-HCD-V1_0.docx	<b>Instruction manual</b>

## 8 Firmware update

Firmware updates are available to download from the ROTRONIC website. The AC3001 cable can be used to connect the HCD probe to a PC (see **E-M-HC2-accessories**). Firmware updates can be carried out using the RMS-CONFIG or RMS server software.



<b>HygroClip2 DIGITAL</b>	<b>rotronic</b>
E-M-HCD-V1_0.docx	Instruction manual

## 9 Technical specifications

General	
Device type	Humidity and temperature probe
Range of application	-40...+85 °C / 0...100 %RH
Mechanical configuration	See variants
IP protection	IP65

Power supply / connection	
Power supply (VDD)	3.3...5 VDC ±0%
Current consumption	<0.5 mA
Maximum inrush current	<200 mA for 50 µs
Maximum operating current	<2 mA
Polarity protection	Mechanical protection

Humidity measurement	
Sensor	ROTRONIC HYGROMER® HT-1
Measurement range	0...100 %RH
Measurement accuracy	±0.8 %RH at 10...30 °C
Long-term stability	<1 %RH / year
Sensor response time	Typically 30 sec, for 63 % of 35 to 80 %RH step (1 m/s wind speed at sensor)

Temperature measurement	
Sensor	Pt1000 RTD, IEC 751 1/3 Class B
Measurement range	-40...+85 °C <sup>5</sup>
Measurement accuracy	±0.1 °C at 10...30 °C
Long-term stability	<0.1 °C / year
Sensor response time	Typically 3 min, for 63 % of the temperature change (1 m/s wind speed at sensor)

<sup>5</sup> The peak load at 200 °C is 100 h. See the sensor data sheet for detailed information on the pollution loads.

<b>HygroClip2 DIGITAL</b>	<b>rotronic</b>
E-M-HCD-V1_0.docx	Instruction manual

Calculated parameters	
Psychrometric calculations	None

Start time / measurement interval	
Start time	90 ms (typical)
Measurement interval	500 ms (typical)

Digital interface	
Type	UART
Factory default	Baud rate 19200, tolerance 2 % Parity: none Data bits: 8 Stop bits: 1 Flow control: none
Logic levels	Logic 0: $\leq 0.4$ V Logic 1: $\geq 2 \dots 2.5$ V
Maximum cable length	3 m

<b>HygroClip2 DIGITAL</b>	<b>rotronic</b>
E-M-HCD-V1_0.docx	Instruction manual

General specifications	
Housing material	See variants
Thumb-screw material	Stainless steel, DIN 1.4301
Filter material	See variants
Dimensions	See variants
Weight	See variants

Conformity	
CE / EMC	EMC Directive: 2014/30/EU  EN 61000-6-1:2007 EN 61000-6-2:2005 EN 61000-6-3:2007+A1:2011+AC:2012 EN 61000-6-4:2007+A1:2011 EN 61326-1: 2013  Performance criterion: <a href="http://www.rotronic.com">www.rotronic.com</a>
Soldering	Lead free (RoHS Directive 2011/65/EU)
FDA/GAMP guidance	Compatible

Accepted environmental conditions	
Storage/transportation	-50...+100 °C / 0...100 %RH, non-condensing
Range of application electronics	-50...+100 °C 0...100 %RH, non-condensing
Maximum wind velocity	50 m/s (according to filter specifications)
Critical gases	See HT-1 sensor data sheet

<b>HygroClip2 DIGITAL</b>	<b>rotronic</b>
E-M-HCD-V1_0.docx	<b>Instruction manual</b>

## 10 Accessories

All accessories for the HCD probe such as extension cables, adapters, calibration material, etc. are to be found in the manual **E-M-HC2-accessories**.

<b>HygroClip2 DIGITAL</b>	<b>rotronic</b>
E-M-HCD-V1_0.docx	<b>Instruction manual</b>

## 11 Additional documents

<b>Document name</b>	<b>Contents</b>
<b>E-M-HC2-accessories</b>	Accessory parts for probes and transmitters
<b>E-M-CalBasics</b>	Temperature and humidity adjustment, basic knowledge when dealing with Rotronic humidity standards
<b>E-T-HumiDefs</b>	Humidity term definitions

<b>HygroClip2 DIGITAL</b>	<b>rotronic</b>
E-M-HCD-V1_0.docx	<b>Instruction manual</b>

## 12 Document version

Version	Date	Remarks
V1_0	March 2017	First version